



# TWENTEBELT

METAL CONVEYOR BELTS



EYELINK BELTS



## ► TABLE OF CONTENTS

2	TWENTEBELT EYELINK BELTS
4	CONSTRUCTION
4	MATERIALS
4	VERSIONS
6	SIDE FINISHING
7	OPTIONS
8	SPECIFICATIONS
8	DIMENSIONS
9	SUPPORT
10	SIDE GUIDANCE
11	DRIVE
13	IDLER
13	TENSIONING AND ADJUSTING
14	OPERATING CONDITIONS
15	REQUEST FOR QUOTATION SHEET
16	ABOUT TWENTEBELT
16	IMPRESSION OF PRODUCT GROUPS

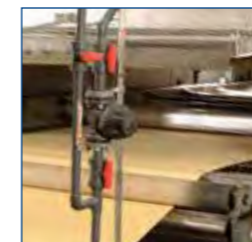

## ▶ TWENTEBELT EYELINK BELTS



Drying tunnel



Deep - frying line

In the course of many years, Twentebelt has developed a lot of experience in the field of eyelink belts and their range of application. This brochure will describe the technical features of our eyelink belts. This information is to support your specifications and the selection of eyelink belts. If you miss any information in this brochure, please do not hesitate to contact us, and we will take pleasure in helping you.

Eyelink belts are produced of stainless steel or other alloys. They consist of a series of eyelinks or eyelink modules. Joined with cross rods they form a flat, simple surface, which is extremely stable and durable. The qualities of this versatile conveyor belt form a combination of advantages that make it particularly suitable for the most demanding applications in a.o. the food, chemical, pharmaceutical and packaging industries.

### The advantages of Twentebelt eyelink belts contribute to more efficient and economic production processes.

Its specific qualities distinguish this metal conveyor belt from the other alternatives on the market:

#### Flat and stable surface

Continuous product support results in a constant final product with a minimal product marking. The products are transported on a flat and stable surface for a consistent processing including packaging.

#### Single level surface

The single level surface excludes a possible 'tunnel effect', which means that products and/or parts will not get entrapped between several layers of the belt. The drainage for air and fluids is excellent, so that the processing circumstances of the different zones hardly influence each other.



Pasteurisation line



Freezing line

#### Slimline belt surface

The limited height of the belt requires only little overall height.

#### Remarkably solid

A considerably longer life span, even under the heavy conditions of a 24/7 production line

#### Easy maintenance

Because of the belt's open structure and the mainly round shapes of its various elements, eyelink belts are particularly easy to clean and hygienic in use. Because of their modular structure the belts can easily be repaired, if necessary.

#### Eyelink belts are extremely versatile and can be used in a wide range of applications.

The Twentebelt eyelink belt efficiently meets the requirements of the most various applications, such as:

- ▶ baking
- ▶ deep-frying
- ▶ pasteurisation
- ▶ blanching
- ▶ cooling
- ▶ freezing
- ▶ drying
- ▶ cooking
- ▶ washing

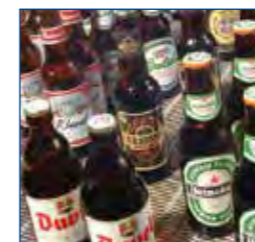



Eyelink, plate link, cross rods

## CONSTRUCTION

An eyelink belt is composed of calibrated eyelinks, plate links and cross rods. Eyelinks are wire elements produced with great precision, whose far ends are eye-shaped, which explains the name. By assembling the eyes on to cross rods a hinge construction is created. Plate links transfer the load to underlying support sections, and are installed in rows at a regular distance.

## MATERIALS

- ▶ Steel (bright)
- ▶ Stainless steel AISI 304
- ▶ Stainless steel AISI 316

Other materials are available on demand and/or on advice.

## VERSIONS



### ▶ Full eyelinks (DO)

The basic principle of all eyelink belt versions. On a full eyelink belt the eyelinks lie against each other, and the opening is equal to the wire diameter. This method can best be used for products likely to fall, or for applications that require small openings.

### ▶ Pressed eyelinks (DP)

Some applications require the smallest opening possible. By flattening the eyes of the eyelinks the opening between the links becomes smaller. This method is very appropriate for small and fine-structured products.



### ▶ Welded eyelinks (DL)

The eyelinks are welded on to a location wire, so that a module is created. Very narrow and very wide openings can be created, depending on the processing of the products concerned. The eyelinks can be set according to European or American assembly, depending on the requirements of hygiene. The standard method is the use of one location wire. The use of more than one location wire will not make the belt more solid. Its only function is related to the dimensions of the product (the desired drain). Modular eyelink belts are stable, also in dimensional respect. The minimal opening is equal to the eyelink diameter + 0,05 mm.



### ▶ Pressed and welded eyelinks (DPL)

Some applications require a stable belt in combination with a small opening/drain. The accuracy of our welding process allows us to produce modules with very small intervals between the eyelinks. The modular structure makes the assembly of very broad belts possible.

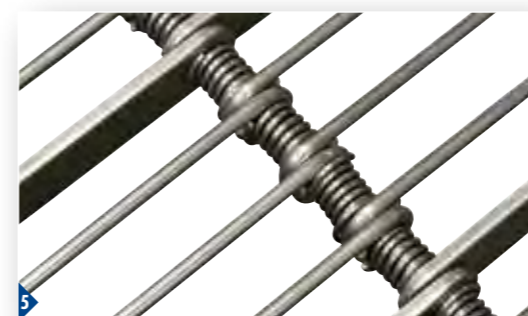

### ▶ Eyelinks with springs (DV)

The placement of springs between the eyelinks ensures that they are positioned at regular intervals. The result is a relatively light belt with specific qualities, such as a good shock resistance and resistance to lateral forces. This is important in situations when the conveyor belt is loaded manually and/or laterally.



### ▶ Eyelinks with bushings or washers (DB)

Bushings or washers are also meant to create an opening between the eyelinks. When bushings or washers are added the belts become heavier and more rigid.

## ▶ SIDE FINISHING



### ▶ Welded edge (LK)

At both sides the belt is fitted with plate links, and the far ends of the cross rods are fitted with washers and subsequently welded. This results in a thorough finishing of the belt in combination with the desired bearing surface.



### ▶ Side chains (KH)

Eyelink belts are usually fitted with chains, if the belt is to perform a negative bend. For this purpose only hollow pin roller chains are used with pitch measurement equal to those of the belt. The selection of the chains depends on the operating conditions.



### ▶ Guide plates (GP)

Guide plates serve as a protection for the welding heads. The plates actually function as a "buffer" between the welding heads and the guidance or other constructions the sides of the belt can get in touch with.

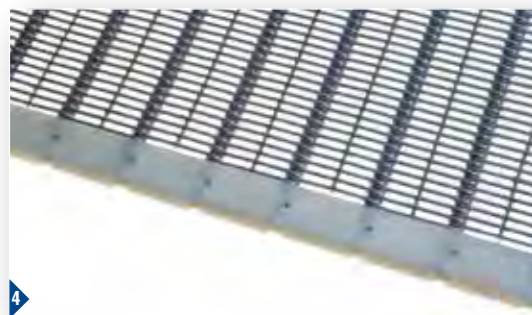

### ▶ Plastic blocks <sup>patented</sup> (KB)

Plastic blocks are a patent item of Twentebelt. This product has several functions, which among other things improve the modular qualities of the eyelink belt (no welds), and generally also the hygiene.

- ▶ A substitution for the plate links
- ▶ No weld, a locking screw is placed into the block
- ▶ Closed, smooth finish of the edges
- ▶ The blocks are made of high-quality injected nylon and replace the plastic support strips; metal longitudinal strips will suffice
- ▶ This saves materials with respect to construction
- ▶ A variant (Ryton PPS) for a higher temperature range can be used up to a temperature of 180 °C

## ▶ OPTIONS

Twentebelt eyelink belts can be provided with different options to meet the requirements of the various applications.

All Twentebelt eyelink belts can be provided with edge plates that make it possible to control the layer thickness of the product to be transported. The height and the shape of the edge plates can be adapted to the sort of product and to the process.

For ascending and/or descending belts flights can be fitted. The shape, measurements and structure (open/closed) of the flights will again be adapted to the sort of product and to the process.



Example of edge plates



Example of a flight

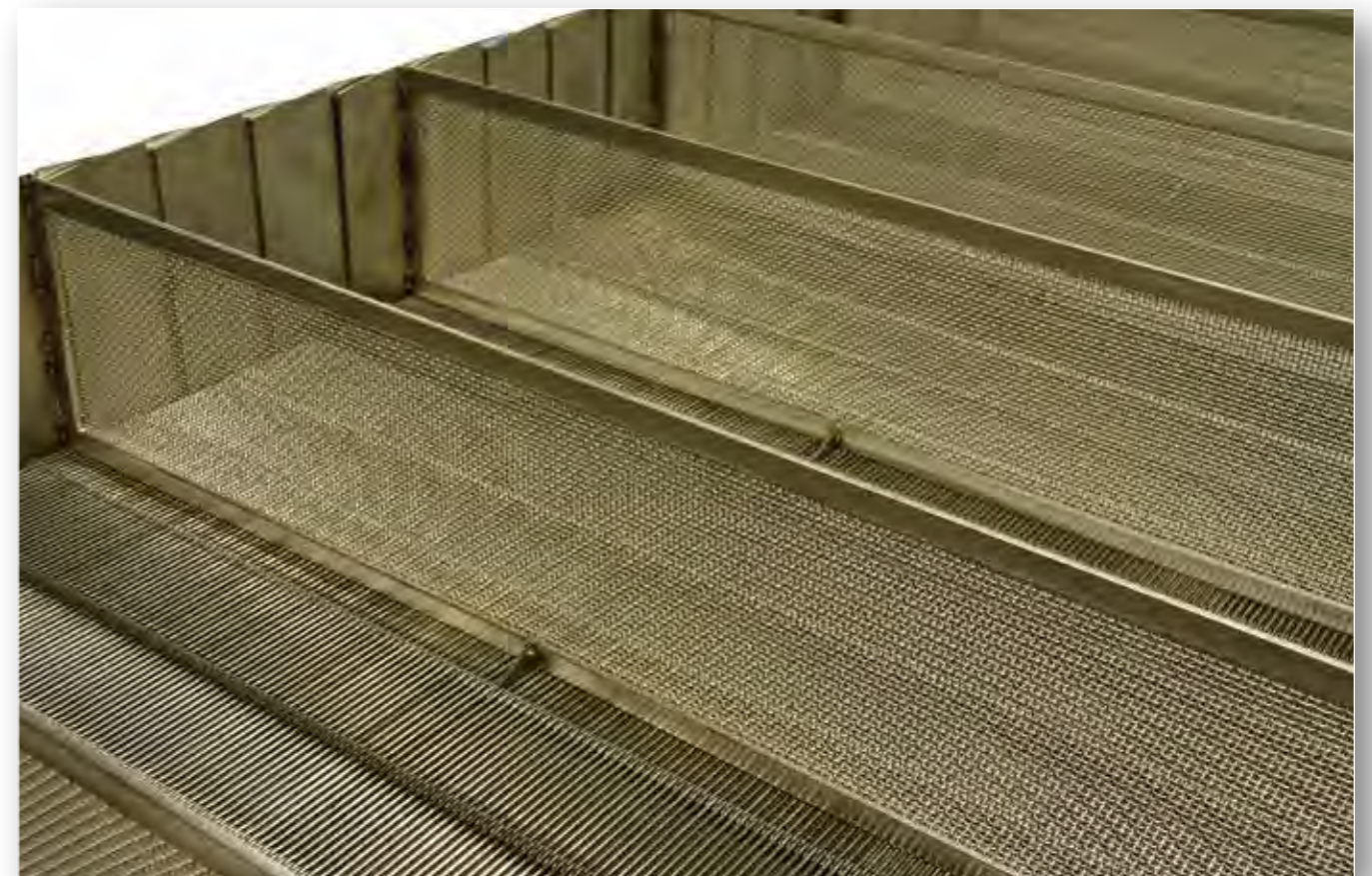

Eyelink belt provided with special flights and edge plates

## SPECIFICATIONS

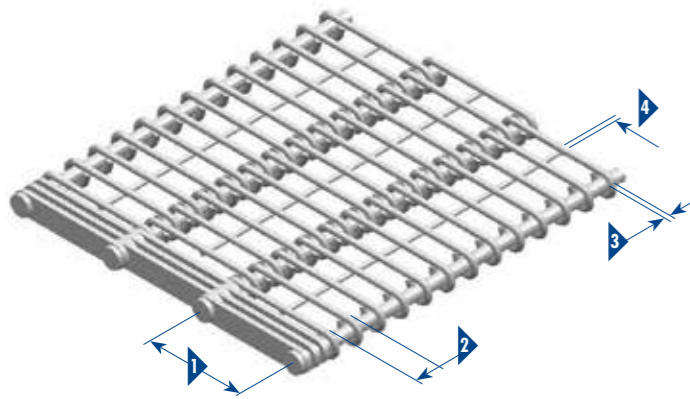

### Explanation of Twentebelts specification method

For example: DL-LK 6-50-2,5-5 location wires 1

- DL-LK => welded eyelink belt - welded edges
  - 6 => cross pitch mm. (centre-to-centre distance of eyelinks)
  - 50 => pitch mm. (centre-to-centre distance of cross bars)
  - 2,5 => wire Ø mm
  - 5 => cross bar Ø mm.
- location wires 0-8

- 1 pitch: centre-to-centre distance of cross rods (15,9 to 76,2 mm)
- 2 cross pitch: centre-to-centre distance of eyelinks (3 to 50mm)
- 3 wire Ø (1,6 to 3,2 mm)
- 4 number of location wires (0-8)

## DIMENSIONS

The table below presents the most common dimensions

Pitch mm	Wire diameter	Cross rod diameter	Minimal centre - to - centre distance between 2 eyelinks	Minimal centre - to - centre distance between 2 eyelinks in welded version
15,9	1,8	3,2	3,6	-
25,4	1,6 2	5	3,2 4	3,25 3*
30	1,6 2	4	3,2 4	3,25 4,05
38,1	2 2,5 3	8	4 5 6	4,05 5,05 6,05
50	1,6 2 2,5 3,2	5 5 5-7 6	3,2 4 5 6,4	3,25 3* 5,05 6,45
50,8	2 2,5 3	5-8 5-8 8	4 5 6	3* 5,05 6,05
75	2,5 3	5-8 8-10	5 6	5,05 6,05
76,2	3	10-13	-	6,05

Of course, deviating specifications are possible. In collaboration with our customers we will always be able to offer an adequate solution.

\*Pressed and welded, type DPL

## SUPPORT

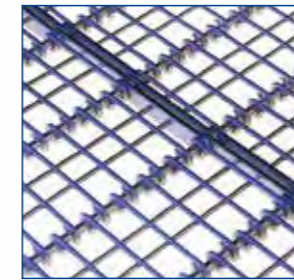

Row of plate links

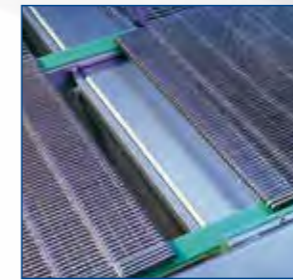

Support sections

Generally two configurations are possible to provide eyelink belts with support: longitudinal support or herringbone support.

### Longitudinal support

The longitudinal support consists of support sections fitted in the longitudinal direction of the installation. These sections are placed at both sides and depending on the width and the load, about every 300 mm right across the width of the belt (see drawing). At the height of those support sections, rows of plate links must be fixed, which will convey the load to the underlying support sections. Depending on the load these rows will consist of one or more plates.

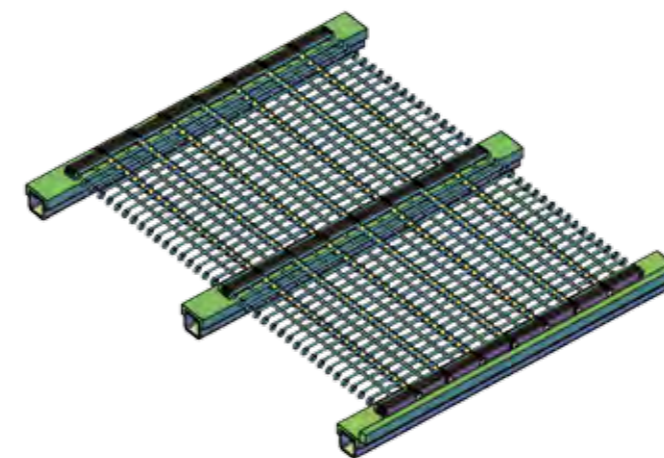

Longitudinal support

### Herringbone support

In a herringbone support structure the support sections (as the name suggests and the drawing illustrates) are positioned in the form of a fish bone. In this case it will be sufficient to place rows of plate links at the edges only. The bearing function will be taken over by the eyelinks. As all eyelinks hit the support strips some time or other, the wearing pattern will be equally spread across the full width of the belt. With this support the product will be equally processed across the full width of the belt. Possible shadow zones, as is the case in longitudinal support structures, will not occur here.

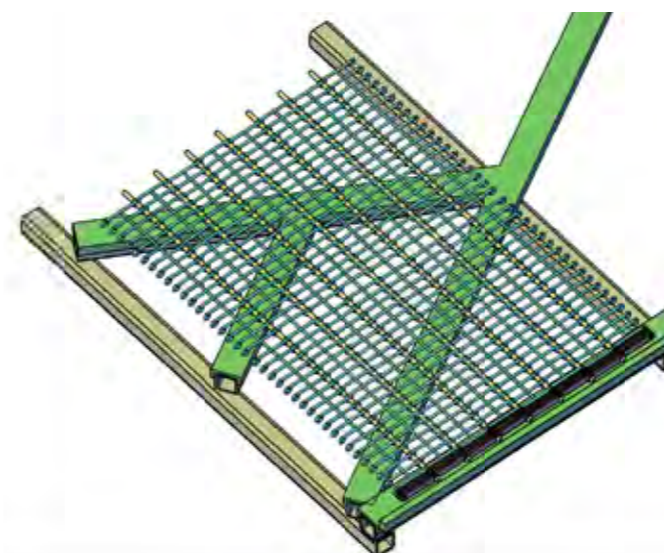

Herringbone support

If hygiene is even a more important issue than usual, we advise you to provide the belt with plate links at the edges only. Because of their round shape eyelinks are easier to clean than plate links. In such a construction the frame will be constructed with a herringbone support, so that filth falling through the belt will immediately be pushed away from the support strips.

### Support return path

The return path only carries the weight of the belt. This is why a lighter support structure is sufficient here. In the longitudinal construction one of two profiles can be left out. The herringbone support can be executed in a less compact form.

## DRIVE

In the return path, the first 500 mm of the belt slacken. There is no support in order to make the formation of a sag possible. The formation of a sag will prevent the belt from climbing on to the drive. It is also necessary in order to prevent the belt from being pushed instead of pulled through the return path. At both ends the support sections should be slightly bent down, in order to establish a gradually guidance of the belt on to and off the profiles.

Rollers can also serve as a support to restrict the frictional coefficient. The rollers must be at right angles to the frame, parallel to each other and level. The distance between the rollers is irregular, in order to prevent an irregular run.

### Frictional coefficient

Below you find an indication of the frictional coefficient for the different alternatives:

- ▶ value of 0,20 - 0,25 with plastic strips, if high-quality
- ▶ value of 0,70 with metal strips, the hardness of the strips should be higher than that of the plate links. In this case we advise the use of spring steel material.
- ▶ value of 0,10 in case of rollers supported on bearings, only in the return path and for belts provided with plates with the wearing course on top.

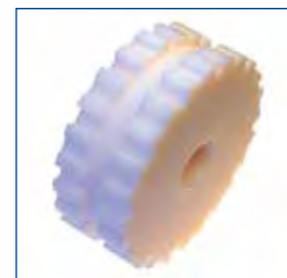

Plastic drive sprocket



SS sprocket

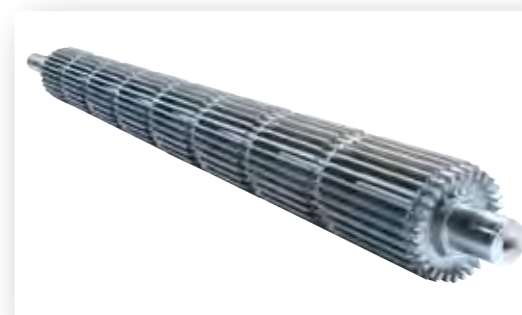

Cage roller



Disc roller

### Sprockets

Generally, eyelink belts are driven directly on the eyelinks by means of specially developed drive sprockets. In case of belts with a large cross pitch (centre-to-centre distance of eyelinks) one could consider to place sprockets that are directly driven on the cross rod instead of on the eyelinks. Generally the sprockets are placed at both sides and under each row of plate links. The width, the number of teeth and the material of the sprockets are determined on the basis of the conditions of use.

When a construction of drive sprockets is applied in a freezer, sprockets with special toothing are used. In order to prevent the accumulation of ice, the so-called "ice-crusher" sprockets are used. The special toothing limits the accumulation of ice to the minimum.

Sprockets are available in steel, AISI 304, AISI 316, PA6G and POM, or in other materials on request.

### Cage rollers

Broad and heavily loaded belts are preferably driven by rollers right across the width of the belt, cage rollers in most of the cases. The straps of the roller regularly drive all the eyelinks of the pitch, which is conducive to a longer life span of the belt and also leads to a regular wear pattern.

### Disc rollers

If there is a risk of accumulation of filth or ice, disc rollers should preferably be used. On a multiple of the cross pitch these rollers are provided with discs. These discs can be produced in different ways, so that different properties can be created:

- ▶ drive on the cross rod
- ▶ drive on the cross rod with a "lifting function", where the teeth protrude through the belt and lift the product for discharge.

## SIDE GUIDANCE

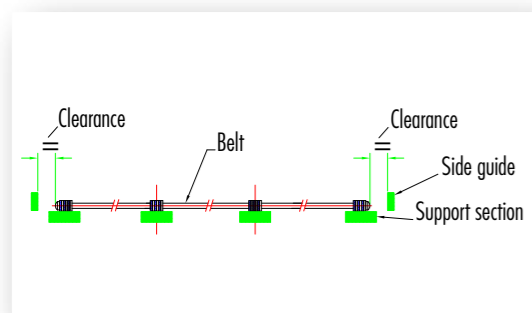

Side guidance

Side guidance is achieved by vertical profiles at both sides of the installation. These profiles should not get in contact with the belt. They are meant to guide the belt in case it deviates from the carrying path. A clearance of 5 to 10 mm between the profiles and the belt is basically sufficient. The geometry of the frame and the load of the belt are points of attention in the design and the adjustment of the installation, because these factors can influence the run of the belt.

The minimal facility at the input side consists of profiles both on top and on the underside, at the discharge side, however, only on top. The maximal facility consists of profiles over the full length of the carrying path and the return path with the exception of the sagging part. The compromise is the placement of profiles of 300 to 500 mm length every 2000 mm.

The appropriate configuration is also determined by the speed, the length, the width and the load of the belt. In case of doubt, please contact us. We will be pleased to think along with you.



SS chain sprocket

### Tube rollers

The strongest drive drum is the tube drum, a thick-walled carbon steel or stainless steel tube with milled teeth and welded in shaft ends. The biggest advantage of the tube construction is that it limits deflexion which is especially important with long, wide and heavily loaded belts. When drive shaft ends are fitted on both sides of the tube, the drum can be flipped when the teeth are worn out on one side.

### Chain sprockets

Eyelink belts can also be produced with chains, whereby the chain fulfils a driving function. Especially when the belt has to perform a negative bend, as is the case with many applications for freezing or blanching, and for ascending belts. In those applications the side-sprockets are replaced by chain sprockets belonging to the chain applied.

In this case, too, the rule applies that for bigger constructions chain sprockets will be placed in combination with a roller.

In all applications with chains a negative bend of the belt can easily be achieved by means of chain sprockets or wear strips of the hollow pin roller chain. Twentebelt prefers the use of sprockets with at least 12 teeth. This is based on the fact that with this number of teeth the so-called polygon effect will exert hardly any influence on the belt run. If the length and the load of the belt are moderate drive sprockets with a minimum of 8 teeth might be used. The ultimate determination of the necessary number of teeth depends on factors like width, length, load and running speed of the belt.

The pitch diameter of sprockets and rollers can be determined by multiplying the number in column n, which is related to the desired number of teeth (column Z), by the pitch of the belt (T).

Z - n	Z - n	Z - n
8 - 2,6131	16 - 5,1258	24 - 7,6613
9 - 2,9238	17 - 5,4422	25 - 7,9787
10 - 3,2361	18 - 5,7588	26 - 8,2962
11 - 3,5495	19 - 6,0755	27 - 8,6138
12 - 3,8637	20 - 6,3925	28 - 8,9314
13 - 4,1786	21 - 6,7095	29 - 9,2491
14 - 4,494	22 - 7,0267	30 - 9,5668
15 - 4,8097	23 - 7,3439	31 - 9,8845

Pitch circle diameter value for n ( $dst = n \times T$ )



Return shaft

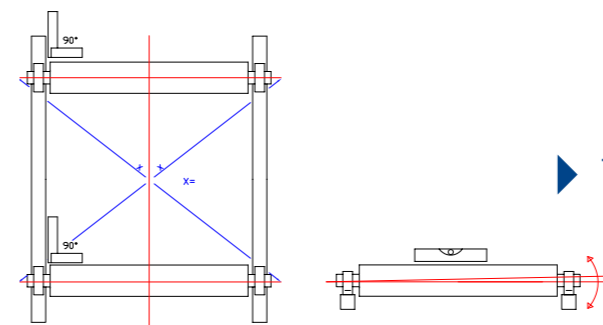

Geometry of the frame



Screw tensioning device

Pitch	Tensioning length
15,9	45
25,4	75
30	90
38,1	110
50/50,8	150
75/76,2	250

Tensioning length per pitch

## IDLER

As for the return shaft there is a choice between toothed or smooth wheels or rollers. In principle, tothing only has a function in case of accumulation of ice or filth. Tothing on the return shaft consequently has no drive function. Generally, in small installations one prefers to provide the return shaft with toothed wheels. When, however, a cage roller was chosen to drive the belt, a smooth roller will be chosen for the return shaft. An exception to this is a drive with cage rollers and chain wheels, whereby the same construction is used as a return roller.

If provided with one tooth per pitch the rollers are one-directional and thus only to be used for drive or for return. Rollers with double strips can be used for both drive and return, if the installation is designed for this purpose.

## TENSIONING AND ADJUSTING

Eyelink belts should run under light tension. However, no exact value can be given for the tensioning of the belt. One should be able to lift the belt with one finger. In operating condition, the formation of a small sag under the drive end is allowed. Of course, this depends on the length and the load.

In general, the return shaft is the one for tensioning and adjustment. In case of short belts and insufficient geometry of the frame this can lead to a bad drive (see drawing).

In most cases a screw tensioning device will suffice. In the case of a continuous tensioning device, hydraulic, pneumatic or with springs, there is always the risk of a certain amount of uncontrolled stretching that tends to elongate the belt.

The table to the left provides the tensioning length per pitch. It has to be taken into account when the shaft has to be adjusted. The tensioning force = (the weight of the belt in the return part x the friction coefficient) x 9,8.



▶ OPERATING CONDITIONS

Material	Min. temp. °C	Max. temp. °C
Steel (bright)	0	220
AISI 304	- 80	350
AISI 316	- 80	350

Temperature range

**Temperature** Eyelink belts can be used within a relatively broad temperature range. See table.

**Speed** The maximum constant speed is 25 m/min. Brief peaks in speed up to 60 m/min. are possible with reservation. Eyelink belts provided with chains limit the maximum speed to 25 m/min.

**Load** Because of the many variable factors the permitted load will be determined for you on request.

**Negative bend** In case of negative bends of DL belts a point concentrated load can occur in the zone of the location wire. As a result of repeated minimal bends the eyelinks can break. The use of special guidance strips with a wide radius offers a solution.

**Cleaning** The materials we use for the production of our belts are suitable for contact with food.

▶ Twentebelt eyelink belts in principle are delivered without any previous treatment or cleaning. During the production process of both the wire and the belt itself only vegetable oils are used. Afterwards the welding heads are brushed. If you wish so, your Twentebelt eyelink belt can be cleaned before delivery. High pressure steaming or pickling and passivating are appropriate methods.

Because of the risk of filth during the assembly in, the belt should preferably be cleaned after the installation!

- ▶ Caustic soda and citric acid for stainless steel materials or any other suitable cleanser, ask your supplier.
- ▶ Combinations of SS belt + C steel side chains should be cleaned with steam or hot water only and appropriate cleansers. Ask your supplier of cleansers. Citric acid corrodes C-steel.
- ▶ C-steel belts should be cleaned with steam or hot water and suitable cleansers. Ask your supplier.

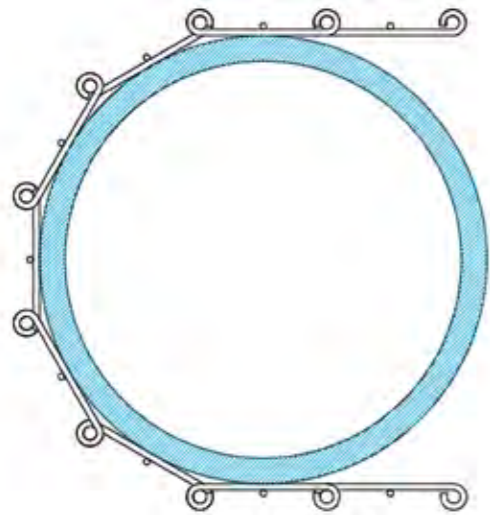

Negative bend

PLEASE NOTE: drive and return wheels are often produced in plastic versions. In that case they are not resistant to certain cleansers. You are kindly requested to keep to the valid cleansing procedures during the installation of your machine, and, if necessary, to adjust the choice of your materials to them.

**Assembly / installation**

For this specific information we kindly refer you to our installation manual, which is available on request.

▶ REQUEST FOR QUOTATION SHEET

▶ CONTACT

Company	Date
Address	Contact person
Postal code	Telephone
City	Fax
Country	Email

▶ BELT SPECIFICATION

- Type:  Full (DO)  With springs (DV)  Pressed (DP)  
 With welded location wire (DL)  With bushings (DB)  Pressed & welded (DPL)

Length \_\_\_\_\_ Number of plate links per row \_\_\_\_\_  
 Width \_\_\_\_\_ Number of rows of plate links \_\_\_\_\_  
 Material \_\_\_\_\_

- 1 Pitch (centre-to-centre distance cross bars) \_\_\_\_\_  
 2 Cross pitch (centre-to-centre distance eyelinks) \_\_\_\_\_  
 3 Wire diameter \_\_\_\_\_  
 4 Number of location wires \_\_\_\_\_

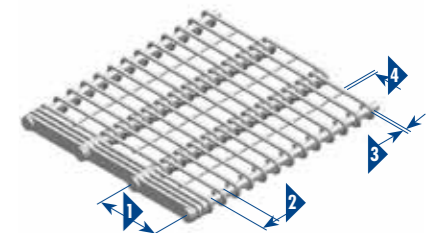

▶ FINISH OF EDGES

- Welded edge (LK)  Chain (KH):  
 Guide plates (GP) Type \_\_\_\_\_ Material \_\_\_\_\_  
 Plastic blocks (KB) Pitch \_\_\_\_\_

▶ OPTIONS *If possible, please add drawing/sketch*

- Edge plates Height \_\_\_\_\_ Material \_\_\_\_\_  
 Flights Height \_\_\_\_\_ Material \_\_\_\_\_ Number \_\_\_\_\_

▶ AREA OF APPLICATION (this information enables us to supply you with the right belt and advice)

Product \_\_\_\_\_ Process \_\_\_\_\_  
 Min. Temperature \_\_\_\_\_ Max. Temperature \_\_\_\_\_  
 Other circumstances \_\_\_\_\_

▶ REMARKS \_\_\_\_\_

## ▶ ABOUT TWENTEBELT

Do you require a different or special conveyor belt that is not listed above? Please contact us to discuss the possibilities.

Twentebelt of the Netherlands has been specialised in metal conveyor belts for over 100 years. Twentebelt develops, produces, supplies and maintains a wide range of metal belts of different types and alloys. With our products and supporting activities we can meet the various requirements of application in o.a. the food-, chemical-, pharmaceutical- and packaging industries. Practically every belt is produced and adjusted to the specific applications of our customers. In the field of eyelink belts Twentebelt has become the worldwide market leader.

## ▶ IMPRESSIONS OF PRODUCT GROUPS

- |                           |   |
|---------------------------|---|
| <b>Eyeblik belts</b>      | 1) Full eyelink belt                      |
|                           | 2) Eyelink belt with welded location wire |
| <b>Wire mesh belts</b>    | 3) Wire mesh belt with S-side             |
|                           | 4) Wire mesh belt with double Z-side      |
| <b>Spiral woven belts</b> | 5) One-sided woven spiral belt            |
|                           | 6) Corrugated wirelink belt               |
|                           | 7) Straight wirelink belt                 |
|                           | 8) Rod reinforced                         |
|                           | 9) Compound belt                          |
| <b>Special belts</b>      | 10) Combinox                              |
|                           | 11) Perforated plate belt                 |
|                           | 12) Filter belt                           |
|                           | 13) Twenteflex                            |

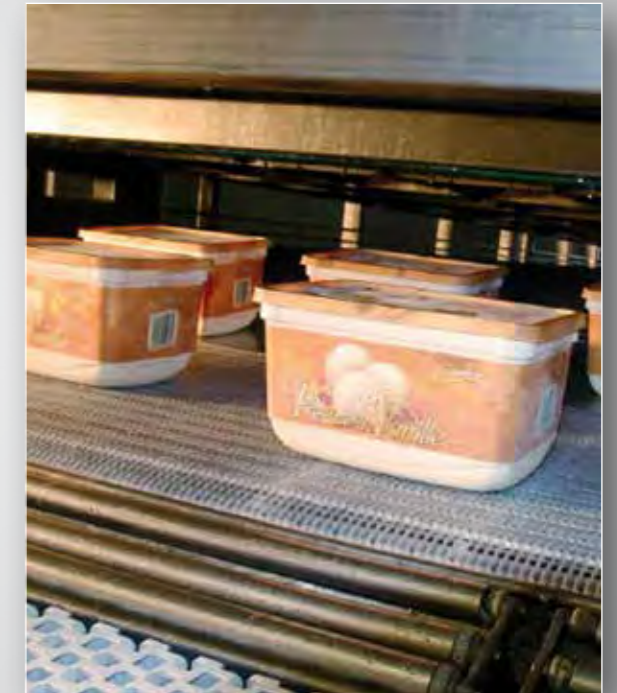
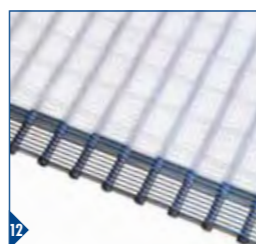
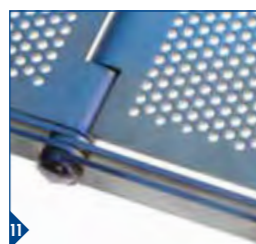
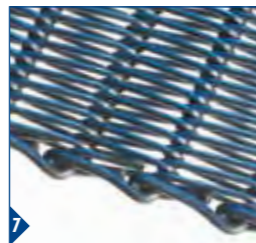
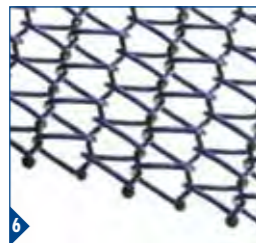
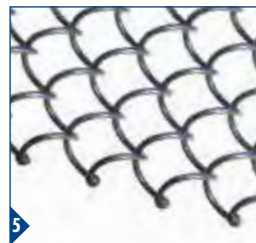
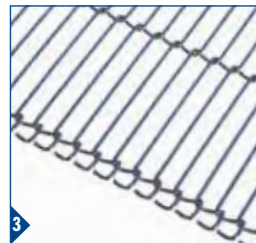
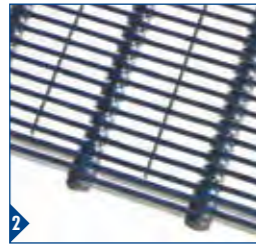
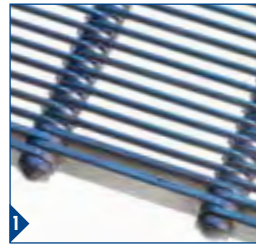



**TWENTEBELT**

**TWENTEBELT BV**

▶ PETROLEUMHAVENSTRAAT 1-3 ▶  
▶ 7553 GS ▶ HENGELO (OV) ▶  
▶ THE NETHERLANDS ▶

▶ TEL +31 (0)74 242 47 05 ▶  
▶ FAX +31(0)74 243 16 59 ▶  
▶ SALES@TWENTEBELT.COM ▶  
▶ WWW.TWENTEBELT.COM ▶

**FlexCAM**

Sole Distributor Australia, New Zealand, Pacific Islands

